

SANTO 70398-DT



Refrigerator/Freezer

Operating Instructions

Dear customer,

Before switching on your new refrigerator/freezer please read these operating instructions carefully. They contain important information for safe use, for installation and for care of the appliance.

Please keep these operating instructions for future reference. Pass them on to possible new owners of the appliance.



Notes which are important for your safety or for the proper functioning of the appliance are stressed with a warning triangle and/or with signal words (Warning!, Caution!, Attention!). Please observe the following carefully.



Additional information regarding operation and practical applications of the appliance appear after this symbol.



Tips and notes concerning economical and environmentally sound use of the appliance are marked with the flower.

In the event of a malfunction, these operating instructions contain information on how to rectify faults yourself, see the "Something Not Working" section.

For further assistance contact your local AEG Service Force Centre, see the chapter "Service and Spare Parts."

Printed on paper manufactured with environmentally sound processes.
who thinks ecologically acts accordingly ...

Contents

Safety	4
Disposal	5
Appliance Packaging Information	5
Disposal of Old Appliances	5
Remove Transport Packaging	6
Prior to Initial Start Up	7
Starting Up and Temperature Regulation	7
Switching the Appliance Off	8
Opening the Freezer Compartment Door	8
Interior Accessories	9
Storage shelves	9
Door rack	9
Moisture regulator	9
Fresh Food Refrigeration	10
Freezing	11
Frozen Storage	12
Preparation of Ice Cubes	13
Freezing Calender	13
Defrosting	14
Cleaning and Care	15
Energy Saving Tips	16
What to do if	17
Correcting Malfunctions	17
Changing the Light Bulb	18
Service and Spare Parts	19
Customer Care Department	19
Guarantee Conditions	20
Installation - Electrical Connection	21
Positioning	22
Reversing the Door	23
Regulations, Standards, Guidelines	24

Safety

The safety aspects of our refrigerator/freezers comply with accepted technical standards and the German Appliance Safety Law. Nevertheless, we consider it our obligation to make you aware of the following safety information:

Intended use

- The refrigerator is intended for use in the home. It is suitable for the cooling, freezing and storing of frozen food, as well as for making ice. If the appliance is used for purposes other than those intended or used incorrectly, no liability can be accepted by the manufacturer for any damage that may be caused.
- Alterations or changes to the freezer are not permitted for reasons of safety.

Prior to initial start-up

- Check the refrigerator for transport damage. Under no circumstance should a damaged appliance be plugged in! In the event of damage, please contact your retailer.

Refrigerant

The refrigerant isobutane (R600a) is contained within the refrigerant circuit of the appliance, a natural gas with a high level of environmental compatibility, which is nevertheless flammable.

- During transportation and installation of the appliance, be certain that none of the components of the refrigerant circuit become damaged.
- If the refrigerant circuit should become damaged:
 - avoid open flames and sources of ignition;
 - thoroughly ventilate the room in which the appliance is situated.

Safety of children

- Packaging (e.g. wraps, polystyrene) can be dangerous for children. There is a risk of suffocation! Keep packaging material away from children!
- Please make old appliances unusable prior to disposal. Pull out the mains plug, cut off the mains cable, break or remove spring or boltcatches, if fitted. By doing this you ensure that children cannot lock themselves in the fridge when playing (there is risk of suffocation!) or get themselves into other dangerous situations.
- Often children cannot recognise the hazards present in household appliances. It is therefore important that you ensure adequate supervision and never let children play with the appliance!

Daily Operation

- Containers with flammable gases or liquids can leak at low temperatures. There is a risk of an explosion! Do not store any containers with flammable materials such as, for example, spray cans, fire extinguisher refill cartridges etc in the refrigerator/freezer.
- Bottles and cans must not be placed in the freezer compartment. They can burst when the contents freeze, high carbonate content drinks can even explode! Never store lemonade, juices, beer, wine, sparkling wine etc. in the freezer compartment. Exception: high alcohol content spirits can be stored in the freezer compartment.
- Do not put ice creams or ice cubes in the mouth immediately after removal from the freezer compartment. Very cold ice can freeze to the lips or tongue and cause injury.
- Do not touch frozen food with wet hands. Your hands could freeze to the food.
- Do not operate any electrical appliances in the refrigerator/freezer (e.g. electric ice cream makers, mixers etc.).
- Before cleaning the appliance, always switch off the appliance and unplug it, or pull the house fuse or switch off the circuit breaker.
- When unplugging always pull the plug from the mains socket, do not pull on the cable.

Service

- Under no circumstances should you attempt to repair the appliance yourself. Repairs carried out by inexperienced persons may cause injury or serious malfunctioning. Contact your local AEG Service Force Centre.

Disposal

Appliance Packaging Information

All materials are environmentally sound!

The plastics can be recycled and are identified as follows:

>PE< for polyethylene, e.g. the outer covering and the bags in the interior.

>PS< for polystyrene foam, e.g. the pads, which are all free of chlorofluorocarbon.

The carton parts are made from recycled paper and should be disposed of at a waste-paper recycling collection location.

Disposal of Old Appliances

For environmental reasons, refrigeration appliances must be disposed of properly. This applies to your old appliance, and - at the end of its service life - for your new appliance as well.



Warning! Before disposing of old appliances make them inoperable. Remove plug from mains, sever the power cable, remove or destroy any snap or latch closures, to prevent small children being trapped inside.

- Use an authorised disposal site.



Contact your local Council or Environmental Health Office to see if there are facilities in your area to recycle the appliance;

Remove Transport Packaging

The appliance and the interior fittings are protected for transport.

- Remove all adhesive tape and packing pieces from the interior of the appliance.

Prior to Initial Start-Up

-  Before connecting the appliance to the mains and putting it into operation for the first time, leave the appliance to stand for 30 minutes if it was transported upright. After transporting on its side, the appliance must be left to stand for 4 hours before switching it on. This is necessary to allow the oil to flow back into the compressor. Otherwise the compressor may be damaged.
-  Please clean the appliance interior and all accessories prior to initial start-up (see section: "Cleaning and Care").

Starting Up and Temperature Regulation

Refrigerator and freezer compartments can not be operated independently of one another.

-  Insert plug into mains socket.

The temperature regulator is on the right side in the refrigerator compartment. It is also the ON/OFF-switch.



Position "0" means:
Cooling OFF

Position "1" means:
Highest interior temperature (warmest setting)

Position "6" means:
Lowest interior temperature (coldest setting)

Recommended settings:

For normal use: position "3" - "4";

-  Turn the temperature regulator to the desired setting. The compressor starts and then runs automatically.
-  Goods to be refrigerated can be loaded immediately after switching on, because the storage temperature in the refrigerator is quickly reached. **Important!** Wait until the freezer compartment has reached a temperature of $-18\text{ }^{\circ}\text{C}$ before storing frozen food.

Note: From a food science point of view, $+5\text{ }^{\circ}\text{C}$ for the refrigerator compartment and $-18\text{ }^{\circ}\text{C}$ for the freezer compartment should be considered cold enough as a storage temperature.

The following effects are of significance in respect of the interior temperature:

- Ambient temperature;
- Quantity and temperature of the food stored;
- Frequency with which the door is opened and how long it is left open.

Switching the Appliance Off

 Refrigerator and freezer compartments can not be switched off independently of one another.

 To switch off, turn the temperature regulator to position "0".

 If the appliance is to be removed from service for a lengthy period:

 Turn the temperature regulator to position "0".

Unplug the appliance, or remove the fuse.

 Defrost freezer compartment and clean thoroughly (see section: "Cleaning and Care").

 Leave doors open after defrosting to avoid accumulation of odours.

Opening the Freezer Compartment Door

If the freezer compartment door is closed when the appliance is in operation, it is possible that it cannot be immediately opened again, because a vacuum occurs in the freezer compartment which holds the door closed until pressure has been equalised. The door can be opened again after several minutes.

Interior Accessories

Storage shelves

- You should always slide one of the full size glass storage shelf into the lowest set of guides, above the fruit and the vegetable containers, and keep it in this position.
- The height of the storage shelves can be adjusted:
- To do this pull the storage shelf forward until it can be swivelled upwards or downwards and removed.
- Please do the same in reverse to insert the shelf at a different height.

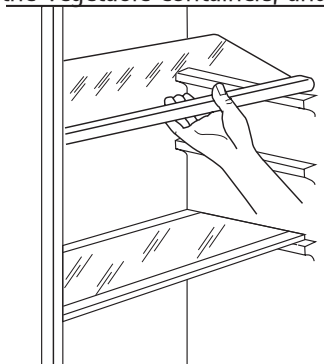

Adjusting the upper door rack

- Depending on the food stored, the upper door racks can be changed to other holders or removed. In order to do this ensure the door racks are empty, press the door racks diagonally upwards at their edges, reposition them, and press them back into place.

Moisture regulator

There is an adjustable air grill in front of the shelf above the fruit and vegetable compartments.

The opening in the ventilation slots can be adjusted with the slider.

Right slider: Ventilation slots opened.

With the ventilation slots open, more air circulation results in a lower air moisture content in the fruit and vegetable compartments.

Left slider: Ventilation slots closed.

When the ventilation slots are closed, the natural moisture content of the food in the fruit and vegetable compartments

is preserved for longer.

When the ventilation slots are closed, the natural moisture content of the food in the fruit and vegetable compartments is preserved for longer.

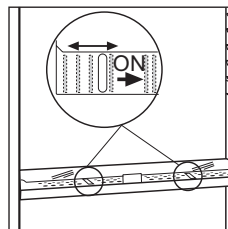
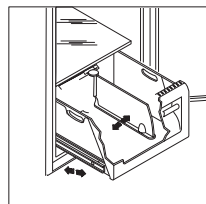

Fresh Food Refrigeration

To obtain the best performance:

- do not store warm food or evaporating liquid in the refrigerator
- do cover or wrap the food, particularly if it has a strong flavour.
- position food so that air can circulate freely round it.

Useful hints:

Meat (all types): wrap in polythene bags and place on the glass shelf above the vegetable drawer(s). **For safety, store in this way only one or two days at the most.**

Cooked foods, cold dishes, etc: these should be covered and may be placed on any shelf.

Fruit and vegetables: these should be thoroughly cleaned and placed in the special drawer(s) provided.

Butter and cheese: these should be placed in special airtight containers or wrapped in aluminium foil or polythene bags to exclude as much air as possible.

Milk bottles: these should have a cap and should be stored in the bottle rack on the door.

Bananas, potatoes, onions and garlic, if not packed, must not be kept in the refrigerator.

Freezing

Attention!

- Before foods are frozen, the actual temperature in the freezer compartment must be -18°C or colder.
- Please observe indicated freezing capacity on the serial plate. The freezing capacity represents the maximum amount of fresh goods that can be frozen within 24 hours. If you freeze goods on several days, one after the other, freeze amounts equal to $2/3$ to $3/4$ of the capacity indicated on the serial plate.
- Thawed foods which have not been processed further (cooked into meals) may not under any circumstances be frozen a second time.

 All foods must be packed air tight prior to freezing, so that they do not dry out or lose their flavour, and so that no flavour contamination of other frozen goods occurs.

Caution! Do not touch frozen goods with wet hands. Hands can freeze to the goods.

 Place packaged foods in the freezer compartment. Unfrozen goods may not come into contact with already frozen goods, otherwise the frozen goods may start to thaw.

Tips:

- The following are suited for the packaging of frozen goods:
 - freezer bags and polyethylene wraps;
 - special containers for frozen goods;
 - extra-thick aluminium foil
- The following are suited for sealing bags and wraps:
plastic clips, rubber bands or adhesive tape.
- Press air out of bags and wraps before sealing, because air encourages drying of frozen goods.
- Make flat packages, because these freeze more quickly.

Note for inspection authorities:

Batch plans for the determination of freezing performance or warm-up time can be requested directly from the manufacturer.

Frozen Storage

Attention! Before initial loading of the freezer compartment with previously frozen goods, the required storage temperature of -18°C must be reached.

The freezer door storage compartment (2 stars) serves only for storage purposes at -12°C . Storage time: 2-3 weeks, depending on food.

- Load freezer compartment only with packaged frozen goods, so that they do not dry out or lose their flavour, and so that no flavour contamination of other frozen goods can occur.
- Please observe maximum storage times and expiry dates of frozen goods.

Preparation of Ice Cubes

1. Fill the ice cube tray 3/4 full with cold water, place it in the freezer compartment and leave to freeze.
2. To loosen the frozen cubes, either bend the ice cube tray or hold it under running water for a few seconds.

Important! Never try to free an ice tray that is frozen to the freezer compartment using pointed or sharp edged objects. Use the ice scraper supplied.

Freezing Calendar

- The symbols on the drawers show different types of frozen goods.
- The numbers indicate storage times in months for the appropriate types of frozen goods. Whether the upper or lower value of the indicated storage time is valid depends on the quality of the foods and pre-treating before freezing. The lower value applies to foods with high fat content.



Defrosting

The refrigerator is defrosted automatically

The integrated evaporator on the rear wall of the refrigerator compartment is defrosted fully automatically.

The water collects in the discharge trough at the back wall of the refrigerator, and is fed through the discharge opening in the catch tray at the compressor where it is evaporated.

Freezer Compartment Defrosting

Moisture is precipitated in the form of white frost in the freezer compartment during operation and when the door is opened. Remove this white frost from time to time with a soft plastic scraper, e.g. a dough scraper. Do not under any circumstances use hard or pointed objects for this purpose.

The appliance should be defrosted when the thickness of the white frost has reached about 4 mm; but at least once a year. A convenient time for defrosting is any time when the appliance is empty, or only minimally loaded.



Warning!

- Do not use electrical heating appliances or any other mechanical or artificial devices to speed up the defrosting process, with the exception of those recommended in these operating instructions.
- Do not use defrosting sprays, because they may be health endangering and/or contain substances damaging to plastics.

Caution! Do not touch frozen goods with wet hands. Hands can freeze to the goods.



Remove frozen goods, pack them in several layers of newspaper, cover them and store them in a cool place, e.g. in a refrigerator.



Switch off the appliance and remove plug from the mains, or switch off or turn out the circuit breaker or the fuse.



After defrosting thoroughly clean the freezer interior, as well as interior accessories (see section: "Cleaning and Care").

Cleaning and Care

For hygienic reasons the appliance interior, including interior accessories, should be cleaned regularly.



Warning!

- The appliance may not be connected to the mains during cleaning. Danger of electrical shock! Before cleaning switch the appliance off and remove the plug from the mains, or switch off or turn out the circuit breaker or fuse.
- Never clean the appliance with a steam cleaner. Moisture could accumulate in electrical components, danger of electrical shock! Hot vapours can lead to the damage of plastic parts.
- The appliance must be dry before it is switched back on.

Attention!

- Ethereal oils and organic solvents can attack plastic parts, e.g.
 - lemon juice or the juice from orange peels;
 - butyric acid;
 - cleansers which contain acetic acid.

Do not allow such substances to come into contact with appliance parts.

- Do not use any abrasive cleansers.
1. Remove frozen food and the food from the refrigerator. Wrap frozen food in several layers of newspaper. Store it in a cool place, well covered.
 2. Defrost the freezer compartment prior to cleaning (see "Defrosting" section).
 3. Switch the appliance off and remove the plug from the mains, or switch off or turn out the circuit breaker or fuse.
 4. Clean the appliance and the interior accessories with a cloth and lukewarm water with a little mild washing up liquid added.

5. After cleaning wipe with fresh water and rub dry.



Accumulation of dust at the condenser increases energy consumption. For this reason carefully clean the condenser at the back of the appliance once a year with a soft brush or a vacuum cleaner.

6. Check the water drain hole on the rear wall of the fridge. Clear a blocked drain hole with the aid of the green peg in the pack of accessories included with the appliance.

7. After everything is dry switch the appliance back on.

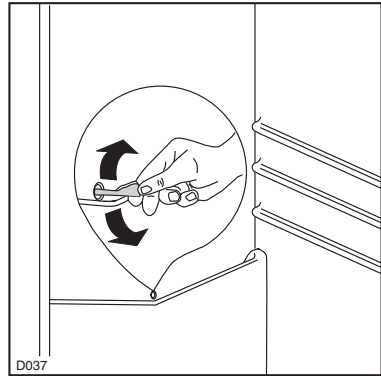

Energy Saving Tips

- Do not install the appliance near cookers, radiators or other sources of warmth. High ambient temperatures cause longer, more frequent operation of the compressor.
- Ensure sufficient air circulation and exhaust at the appliance base and at the back wall of the appliance. Never cover air vent openings.
- Do not place warm foods into the appliance. Allow warm foods to cool first.
- Only leave door open as long as necessary.
- Do not set temperature any colder than necessary.
- Put frozen food in the fridge to defrost. The cold in the frozen food will then be used to cool the fridge.
- Always keep the heat emitting condenser, the metal grill on the rear wall of your appliance clean.

What to do if ...

Correcting Malfunctions

Perhaps a malfunction has been caused by a minor error, which you can correct yourself with the help of the following instructions. Do not attempt any further repairs if the following instructions do not help in each specific case.



Warning! Refrigerator/freezers may only be repaired by trained personnel. Repairs carried out by untrained personnel can lead to substantial danger for the user. Please contact your Service Force Engineer for repairs.





Malfunction	Possible cause	Remedy
Appliance does not function, green stand-by display is not lit.	Appliance is not switched on.	Switch appliance on.
	Mains plug is not inserted or is loose.	Insert mains plug.
	Fuse has blown or is defective.	Check fuse, replace if necessary.
	Mains socket is defective.	Mains malfunctions are to be corrected by an electrician.
The refrigerator and/or freezer compartment temperature is insufficient.	Temperature is not properly adjusted.	Please refer to the section "Temperature Adjustment".
	Door was open for a long time.	Only leave the door open as long as necessary.
	Within the last 24 hours a large quantity of warm foods were loaded.	Turn to colder setting.
	Appliance is next to a source of warmth.	Please refer to the section "Installation Location".
Interior illumination does not function.	Light bulb is defective.	Please refer to "Replace Light Bulb" in this section.

Malfunction	Possible cause	Remedy
Large accumulation of frost in the appliance, perhaps also at the door seal.	Door is not properly sealed	seal with a hand-held hair dryer at those points which are not airtight (no warmer than approx. 50°C). At the same time, shape the warmed door seal by hand, so that it is again properly seated.
Unusual noises.	Appliance is not level.	Readjust the front levelling feet.
	Appliance is in contact with wall or other objects.	Push appliance away a short distance.
	A part at the back of the appliance, e.g. a tube, is in contact with another appliance part or the wall.	Please contact your Local Service Force Centre
The compressor does not start immediately after changing the temperature setting.	This is normal, no error has occurred. Carefully warm the door	The compressor starts after a period of time.

Changing the Light Bulb

⚠ Warning! Danger of electrical shock! Before replacing the light bulb switch appliance off and remove the mains plug, or switch off or turn out the circuit breaker or fuse.

Light bulb specifications: 220-240 V, max. 15 W, fitting: E 14

-  To switch the appliance off turn the temperature regulator to position "0".
-  Unplug the mains plug.
-  To change the light bulb, pull out the screw "Y" and then remove the protective cover "X".
-  Change the defective light bulb.
-  Refit the light bulb cover.

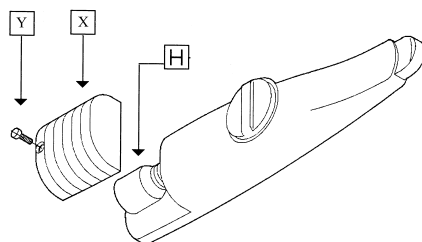

Service and Spare Parts

In the event of your appliance requiring service, or if you wish to purchase spare parts, please contact your local Service Force Centre by telephoning:

0870 5 929929

Your telephone call will be automatically routed to the Service Force Centre covering your post code area.

For the address of your local Service Force Centre and further information about Service Force, please visit the website at www.serviceforce.co.uk.

Before calling out an engineer, please ensure you have read details under the heading "Something Not Working".

When you contact the Service Force Centre you will need to give following details:

1. Your name, address and post code
2. Your telephone number
3. Clear and concise details of the fault
4. The model and serial number of the appliance. (found on the rating plate).
5. The purchase date

Please note that a valid purchase receipt or guarantee documentation is required for in-guarantee service calls.

Customer Care Department

For general enquiries concerning your AEG appliance or for further information on AEG products, please contact our Customer Care Department by letter or telephone at the address below or visit our website at www.aeg.co.uk.

Customer Care Department

AEG Domestic Appliances

55-77 High Street,

Slough,

Berkshire

SL1 1DZ

Tel: 08705 350 350*

*calls to this number may be recorded for training purposes

For Customer Services in the Republic of Ireland please contact us at the address below:

AEG

Electrolux Group (Ire) Ltd

Long Mile Road

Dublin 12

Republic of Ireland

Tel: + 353 (0) 1 4090751

GUARANTEE CONDITIONS

Standard guarantee conditions

We, AEG, undertake that if within 12 months of the date of the purchase this AEG appliance or any part thereof is proved to be defective by reason only of faulty workmanship or materials, we will, at our discretion repair or replace the same FREE OF CHARGE for labour, materials or carriage on condition that:

- The appliance has been correctly installed and used only on the electricity or gas supply stated on the rating plate.
- The appliance has been used for normal domestic purposes only, and in accordance with the manufacturer's operating and maintenance instructions.
- The appliance has not been serviced, maintained, repaired, taken apart or tampered with by any person not authorised by us.
- All service work under this guarantee must be undertaken by a Service Force Centre. Any appliance or defective part replaced shall become the Company's property.
- This guarantee is in addition to your statutory and other legal rights.
- Home visits are made between 8.30am and 5.30pm Monday to Friday. Visits may be available outside these hours in which case a premium will be charged.

Exclusions

This guarantee does not cover:

- Damage or calls resulting from transportation, improper use or neglect, the replacement of any light bulbs or removable parts of glass or plastic.
- Costs incurred for calls to put right an appliance which is improperly installed or calls to appliances outside the United Kingdom.
- Appliances found to be in use within a commercial environment, plus those which are subject to rental agreements.
- Products of AEG manufacture which are not marketed by AEG.

European Guarantee

If you should move to another country within Europe then your guarantee moves with you to your new home subject to the following qualifications:

- The guarantee starts from the date you first purchased your product.
- The guarantee is for the same period and to the same extent for labour and parts as exists in the new country of use for this brand or range of products.
- This guarantee relates to you and cannot be transferred to another user.
- Your new home is within the European Community (EC) or European Free Trade Area.
- The product is installed and used in accordance with our instructions and is only used domestically, i.e. a normal household.
- The product is installed taking into account regulations in your new country.

Before you move please contact your nearest Customer Care centre, listed below, to give them details of your new home. They will then ensure that the local Service Organisation is aware of your move and able to look after you and your appliances.

France	Senlis	+33 (0)3 44 62 29 29
Germany	Nürnberg	+49 (0)800 234 7378
Italy	Pordenone	+39 (0)800 117511
Sweden	Stockholm	+46 (0)8 672 53 60
UK	Slough	+44 (0)1753 219899

Installation

Electrical Connection



Any electrical work required to install this appliance should be carried out by a qualified electrician or competent person.

WARNING – THIS APPLIANCE MUST BE EARTHED

The manufacturer declines any liability should these safety measures not be observed.

Before switching on, make sure the electricity supply voltage is the same as that indicated on the appliance rating plate. The rating plate is inside, on the left.

The appliance is supplied with a 13 amp plug fitted. In the event of having to change the fuse in the plug supplied, a 13 amp ASTA approved (BS 1362) fuse must be used.

Important!

The wires in the mains lead are coloured in accordance with the following code:

Green and Yellow	Earth
Blue	Neutral
Brown	Live

As the colours of the wires in the mains lead of this appliance may not correspond with the coloured markings identifying the terminals in your plug, proceed as follows:

1. The wire coloured green and yellow must be connected to the terminal marked with the letter "E" or by the earth symbol or coloured green and yellow.
2. The wire coloured blue must be connected to the terminal marked "N" or coloured black.
3. The wire coloured brown must be connected to the terminal marked "L" or coloured red.
4. Upon completion there must be no cut, or stray strands of wire present and the cord clamp must be secure over the outer sheath.

Warning! A cut-off plug inserted into a 13 amp socket is a serious safety (shock) hazard. Ensure that the cut-off plug is disposed of safely.

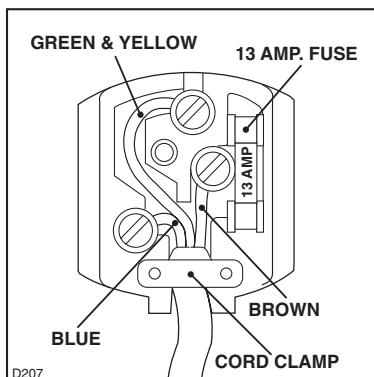

Positioning

This appliance should only be installed at a location where the ambient temperature corresponds to the climate classification indicated on the rating plate, which is located at the left on the inside of the appliance.

The following table shows which ambient temperature is correct for each climate classification:

SN	+10°C to + 32°C
N	+16°C to + 32°C
ST	+18°C to + 38°C
T	+18°C to + 43°C

For correct operation this appliance must be located in a dry atmosphere, away from heat sources, e.g. cookers, radiators, boilers and direct sunlight.

You should also ensure that air can circulate freely around the back and the top of the cabinet. There should be 100mm (4") between the top of the cabinet and any overhanging kitchen furniture. Alternatively allow 50mm (2") between the top of the cabinet and any overhanging kitchen furniture and a gap of 25mm (1") on either side of the appliance.

Do not obstruct the space underneath. The back of the cabinet may be placed close to the wall but must not touch it. **DO NOT** install in places with restricted ventilation.

Adjust the level of the appliance by screwing out the adjustable foot, or feet, at the bottom of the cabinet using your fingers.

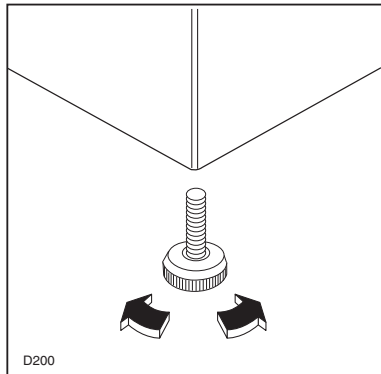
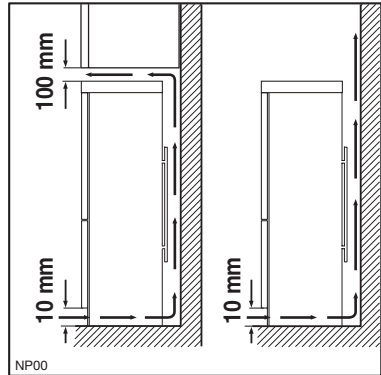

Reversing the Doors

Before carrying out any operations, remove the plug from the power socket.
To reverse the door, proceed as follows:

1. Remove the upper hinge and the upper support taking care that the upper door not fall off ;
2. remove the upper door;
3. unscrew the middle hinge. Unscrew the plastic plugs located on the opposite side of the central hinge and insert them into the holes occupied before by the hinge;
4. remove the lower door;
5. pull off the ventilation grill which is fixed by two screws;
6. remove the bottom hinge by unscrewing its fixing screws;
7. using a 10 mm spanner, unscrew the hinge pin and reassemble it on the opposite side of the hinge;
8. adjust the level of the appliance by unscrewing the adjustable foot, or feet, at the bottom of the cabinet using your fingers or a tool;
9. reassemble the lower hinge on the opposite side, using the screws previously removed. Slide the hole cover out of the ventilation grill by pushing it in the direction of the arrow and reassemble it on the opposite side;
10. refit the ventilation grill , fixing the screws;
11. reassemble the lower door;
12. reassemble the middle hinge on the opposite side;
13. replace the upper door.
14. In your documentation bag you will find the upper hinge and the upper support necessary to make the reversibility. Please mount them in their relevant place.
15. Depending on the model:
Model with bar handle
Dismantle the handles and reassemble them on the opposite side. Cover the-holes with the plastic lids that were situated where the handles are presently

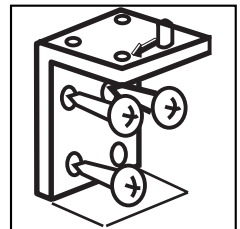
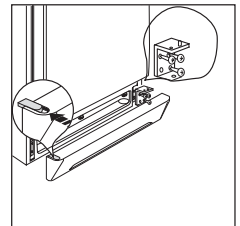
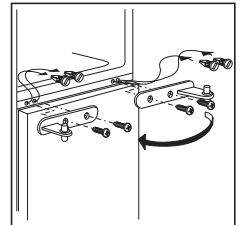
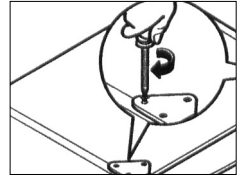

⚠ Caution! Do not overtighten the screws (max. 2 Nm) as you may damage the door handles.

⚠ Warning:

After having reversed the doors check that all the screws are properly tightened and that the magnetic seal adheres to the cabinet. If the ambient temperature is cold (i.e. in Winter), the gasket may not fit perfectly to the cabinet. In that case, wait for the natural fitting of the gasket or accelerate this process by heating up the part involved with a normal hairdrier.

Regulations, Standards, Guidelines

This appliance was designed for household use and was manufactured in accordance with the appropriate standards. The necessary measures in accordance with appliance safety legislation regulations (GSG), accident prevention regulations for refrigeration appliances (VBG 20) and the regulations of the German Society of Electrical Engineers (VDE) were observed in the manufacture of this appliance.

The refrigerant circuit has been checked for leaks.

CE This appliance is in accordance with the following EU guidelines:

– 73/23/EEG dated 19 February 1973 – low voltage guidelines.

– 89/336/EEG dated 3 May 1989

(including guideline change notice 92/31/EEG) – EMV guideline

 **From the Electrolux Group.** *The world's No. 1 choice.*

The Electrolux Group is the world's largest producer of powered appliances for kitchen, cleaning and outdoor use. More than 55 million Electrolux Group products (such as refrigerators, cookers, washing machines, vacuum cleaners, chain saws and lawn mowers) are sold each year to a value of approx. USD 14 billion in more than 150 countries around the world.

AEG
55-77 High Street
SLOUGH
Berks
SL1 1DZ
<http://www.aeg.co.uk>

© Copyright by AEG

214.3617.41 06/04 Subject to change without notice